

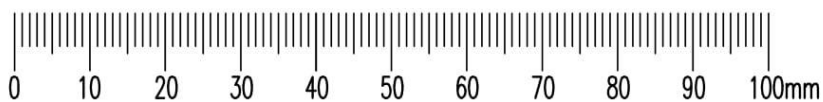

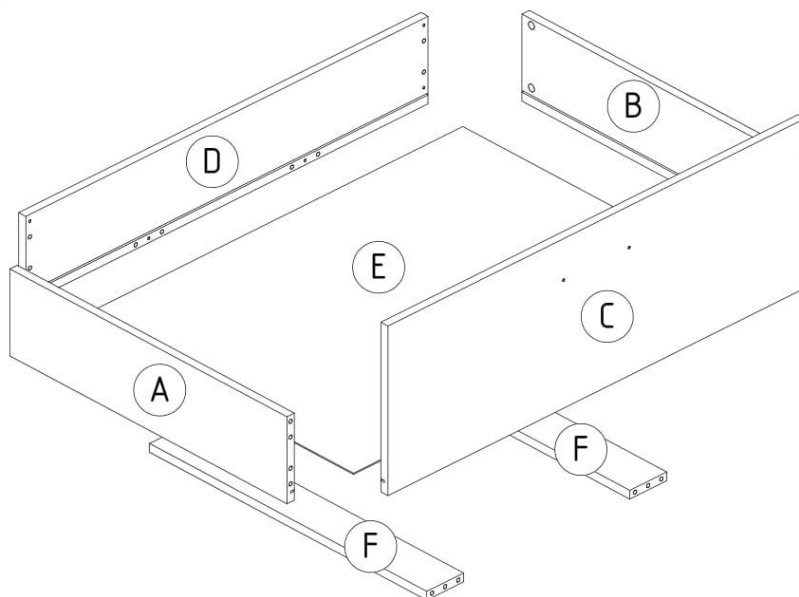

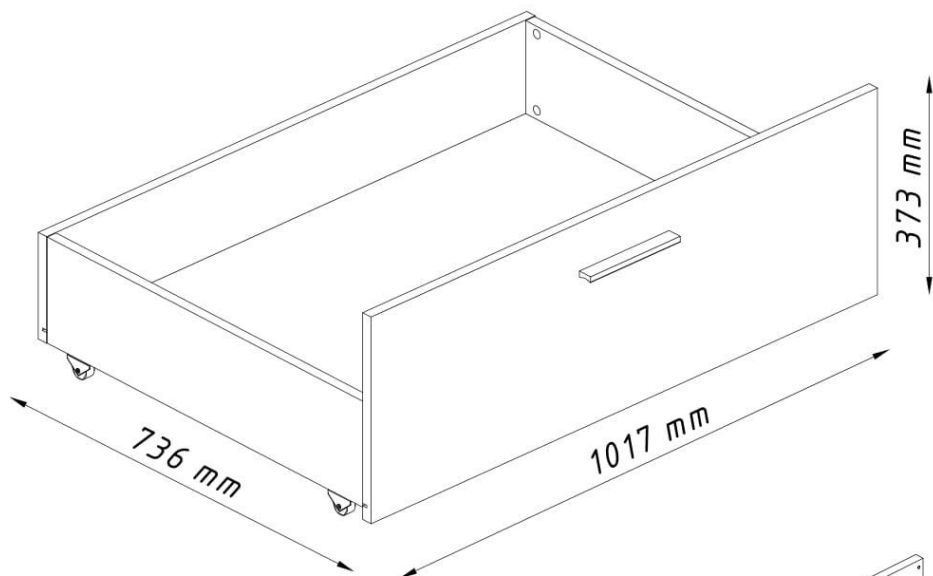



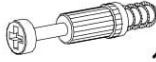

VERSO 1S MODUL

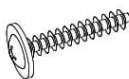

Z1  $\phi 8 \times 30$ 16 x	Z2  $\phi 15 \times 12$ 12 x	Z3  $10 \times 15 \text{ mm}$ 6 x	Z4  4×25 2 x	Z5  1 x
Z6  $\phi 16$ 8 x	Z7  $H=32,5 \text{ mm}$ 4 x	Z8  $10 \times 15 \text{ mm}$ 6 x	Z9  4.2×16 8 x	

1

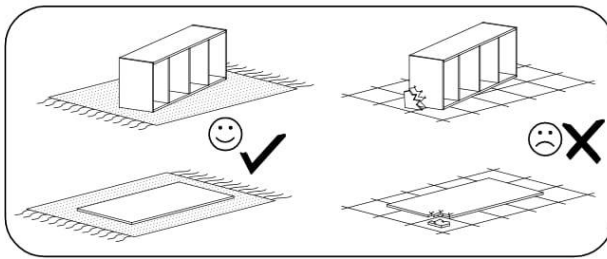

Z1 ø8x30 16x	Z3 ø15x12 12x
Z2 12x	Z5 1x
Z4 4x25 2x	

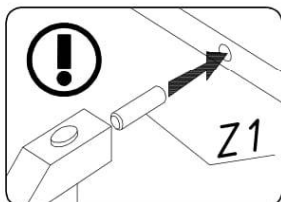
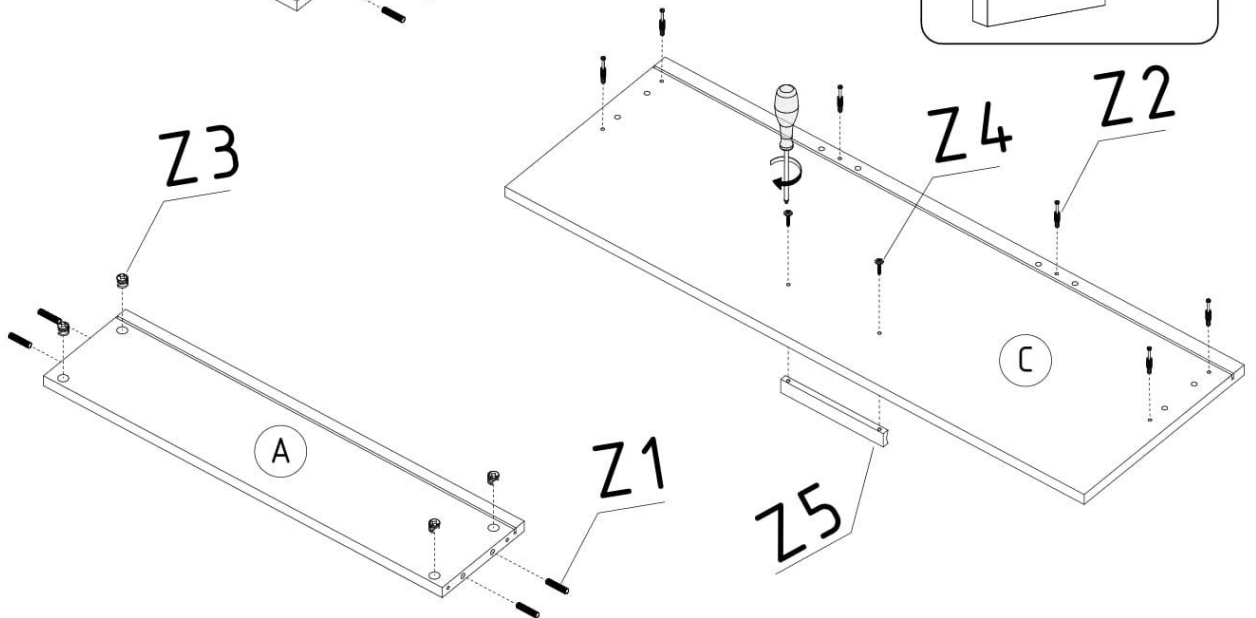
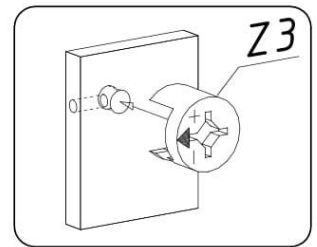
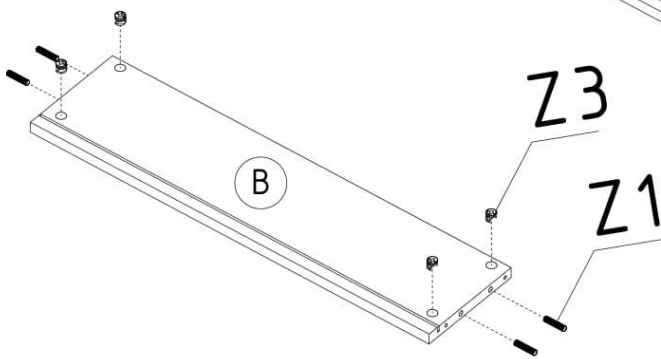
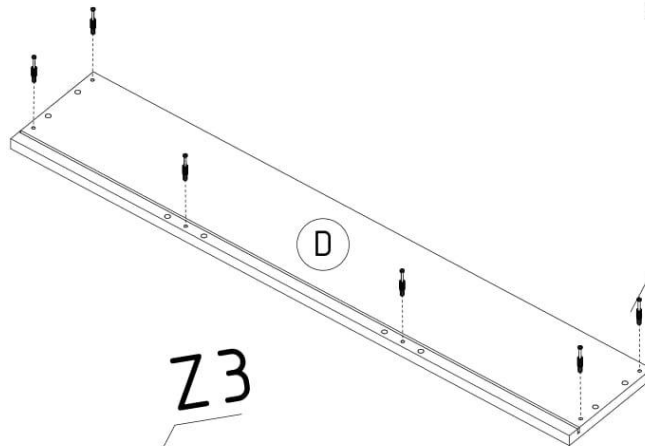
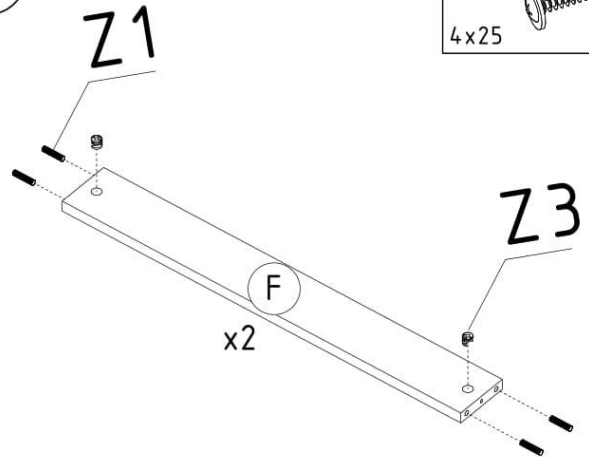
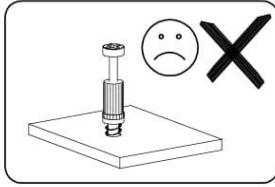
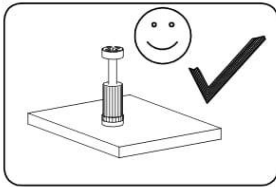

2

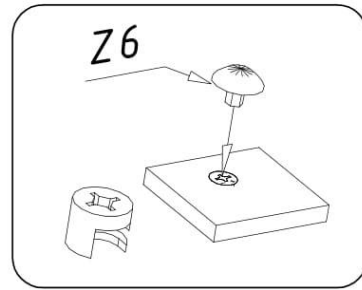

Z6
φ16 4x

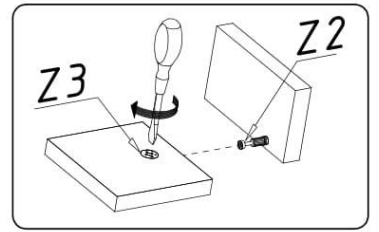
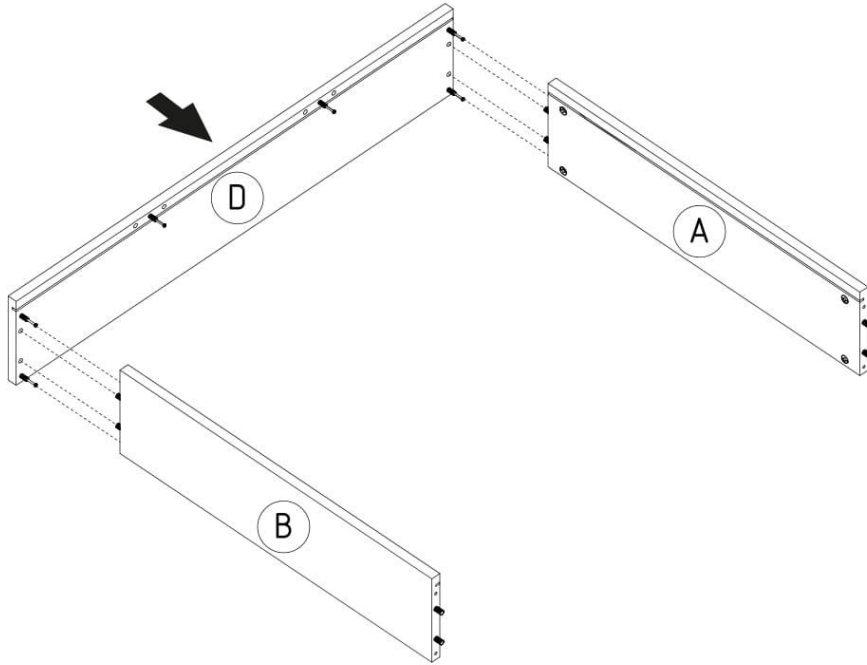

3

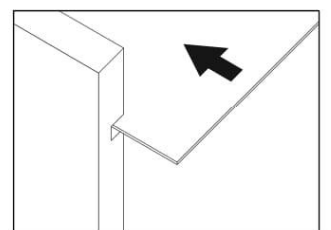
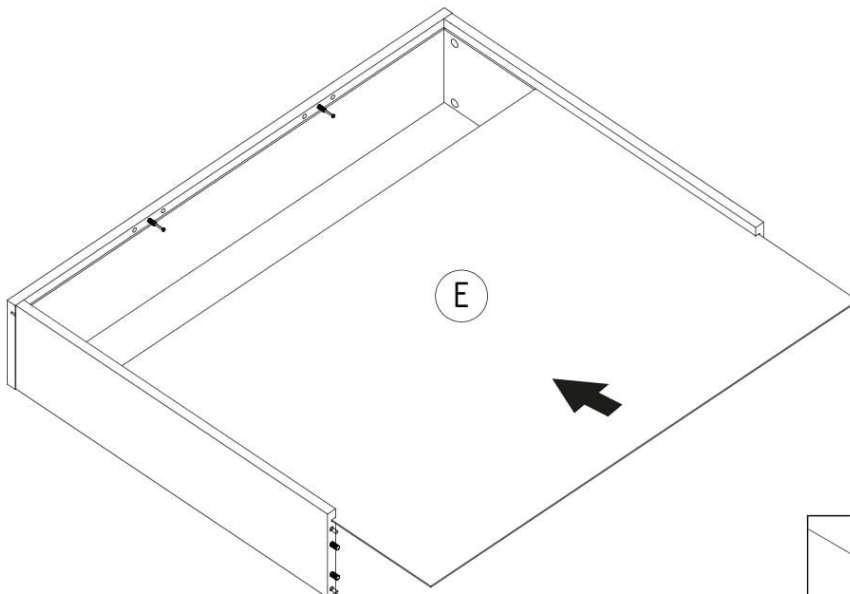

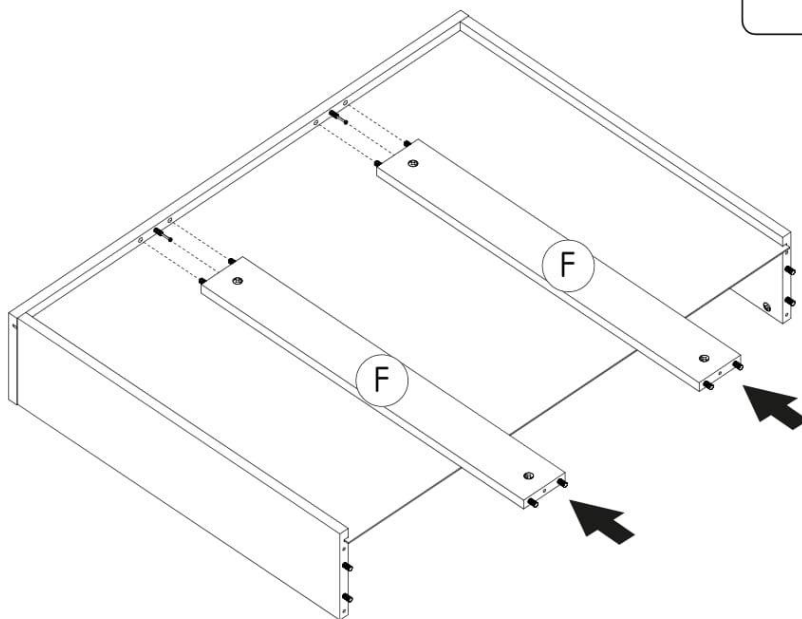
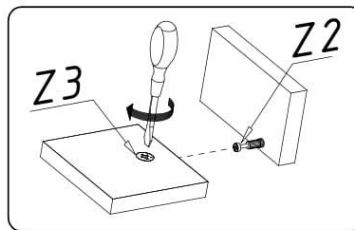

4

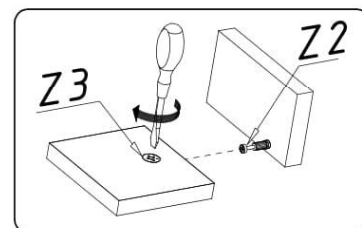
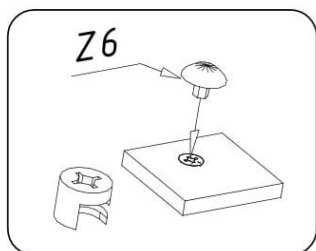
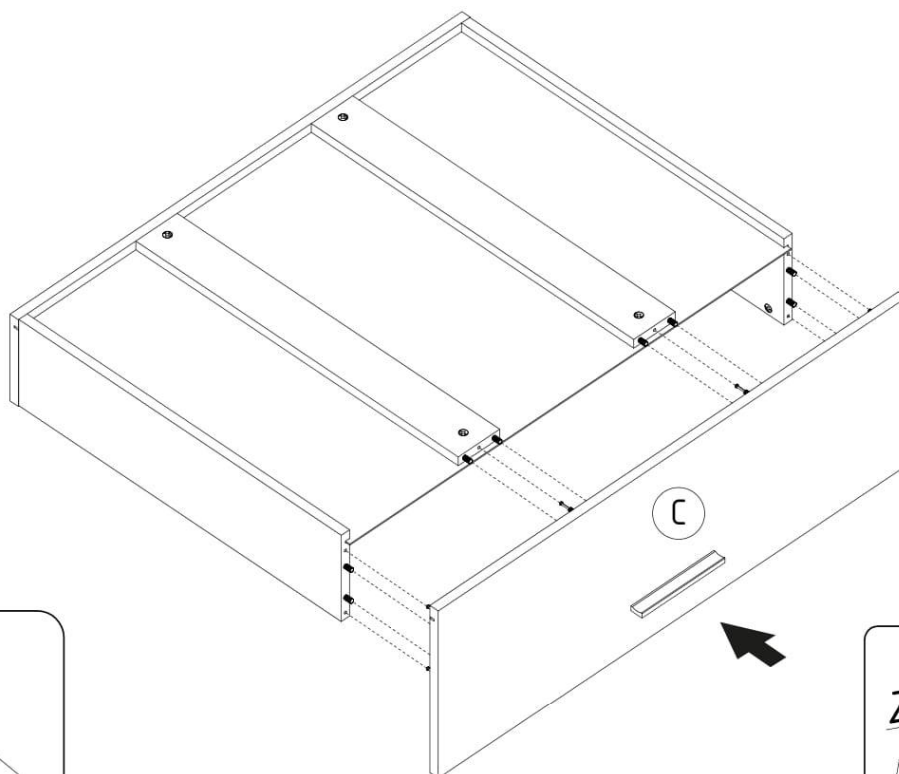
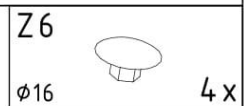

5



6

Z7		Z9		Z8	
H=32,5mm	4 x	4.2x16	8 x	10x15mm	6 x

a=b

