







<p>F</p>  <p>8x</p>	<p>G</p>  <p>8x</p>	<p>H</p>  <p>4x</p>	<p>I</p>  <p>4x</p>
<p>J</p>  <p>3x10mm 16x</p>	<p>K</p>  <p>M8x25mm 16x</p>	<p>L</p>  <p>1x</p>	

1

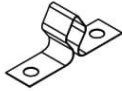

x2

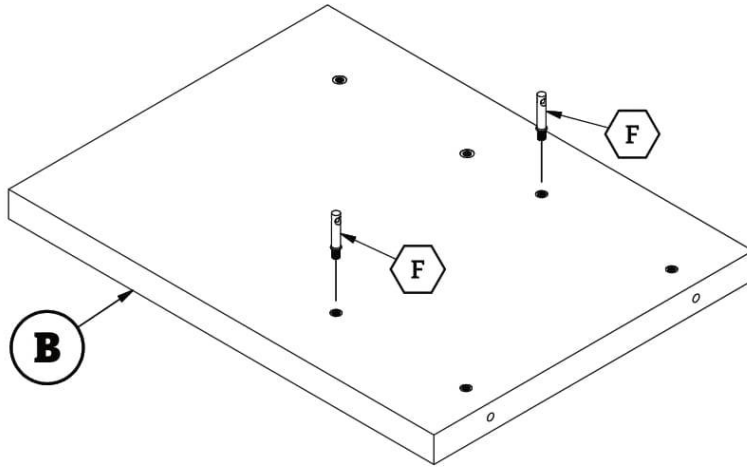
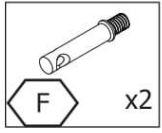
2

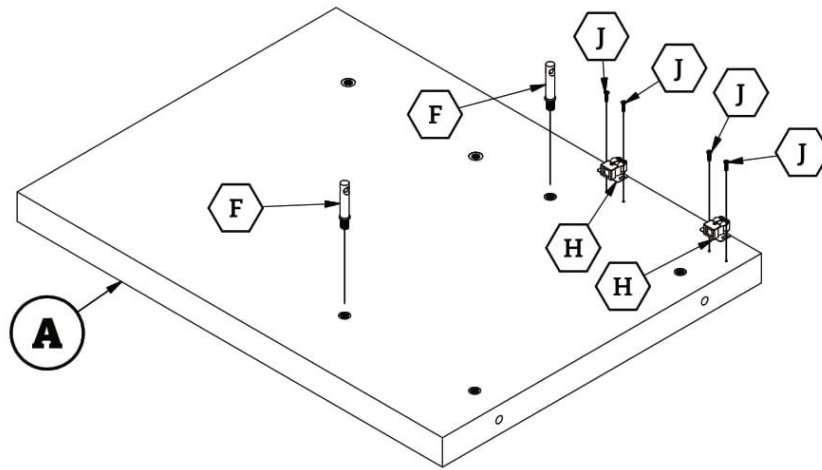
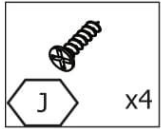
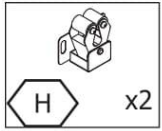
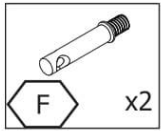

x2

3

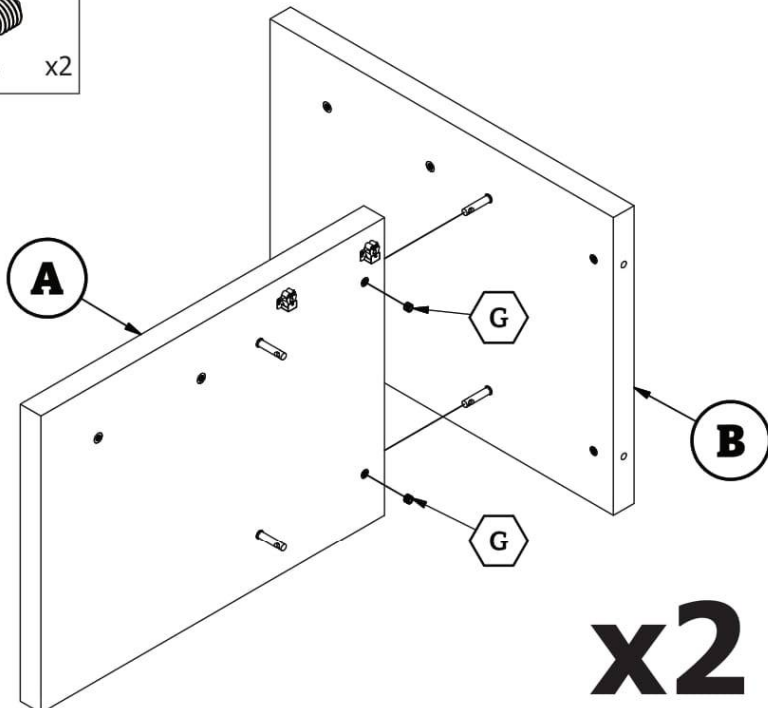

x2

