

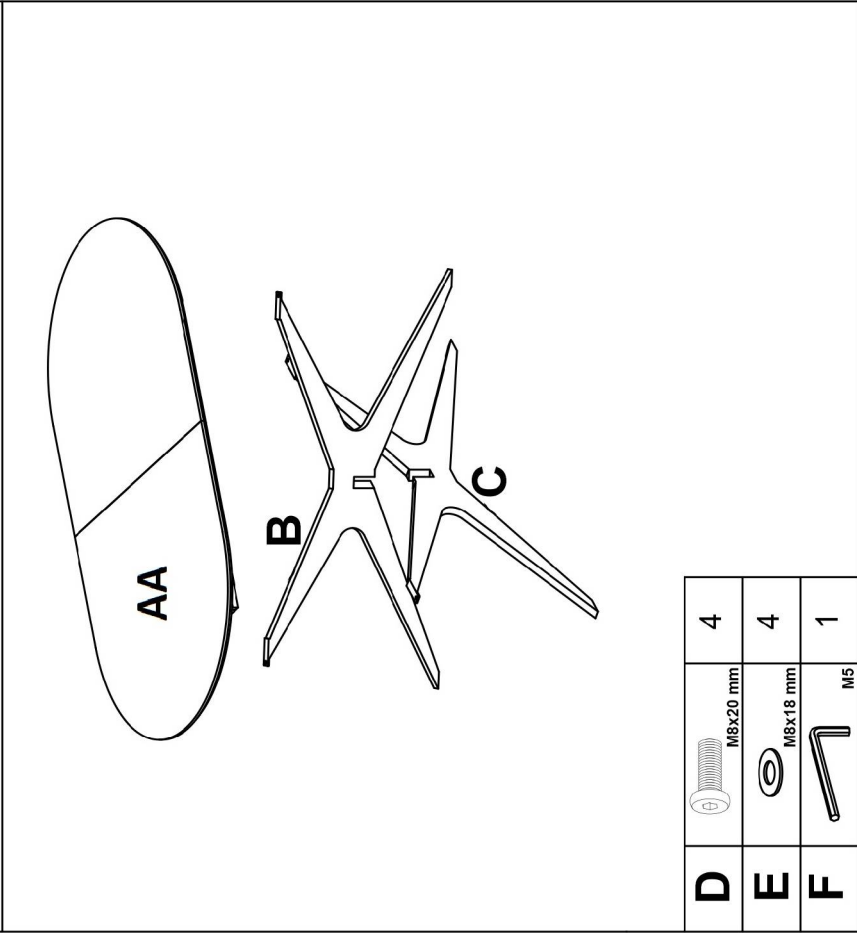

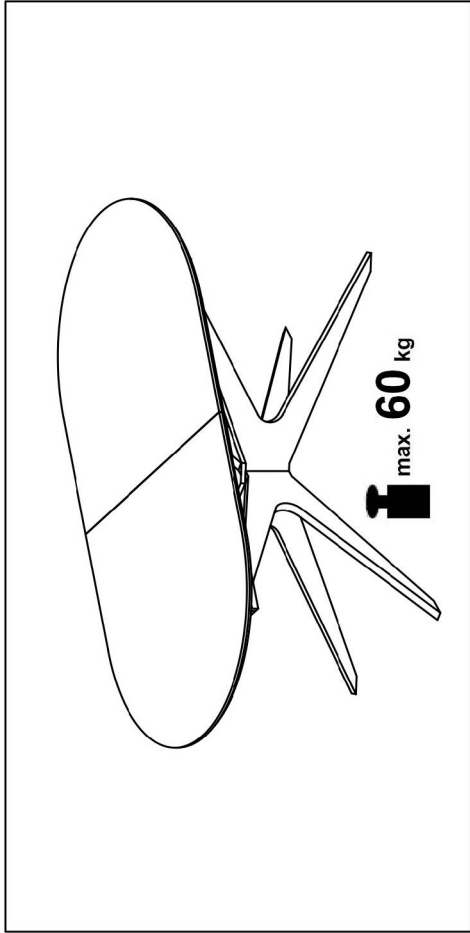

# SANDRO

v.1



|          |  |   |
|----------|--|---|
| <b>D</b> |  M8x20 mm | 4 |
| <b>E</b> |  M8x18 mm | 4 |
| <b>F</b> |  M5       | 1 |

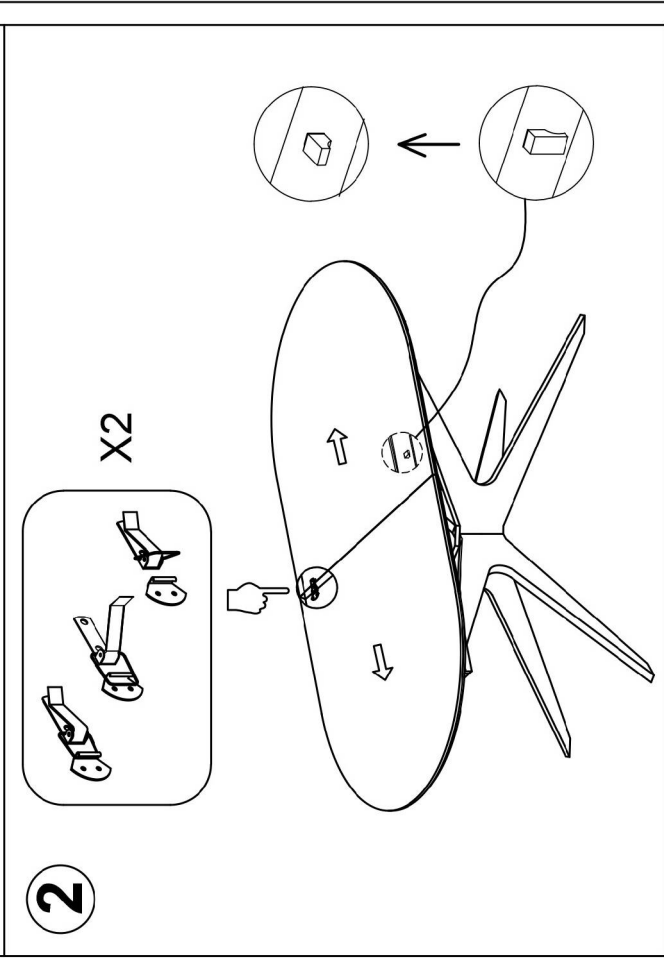
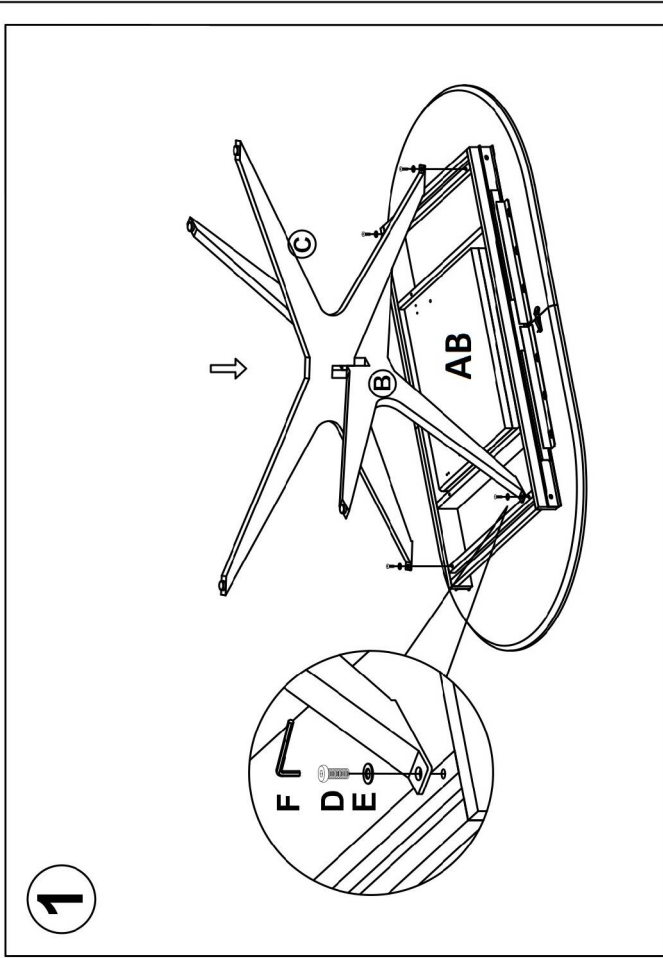

1/2

3

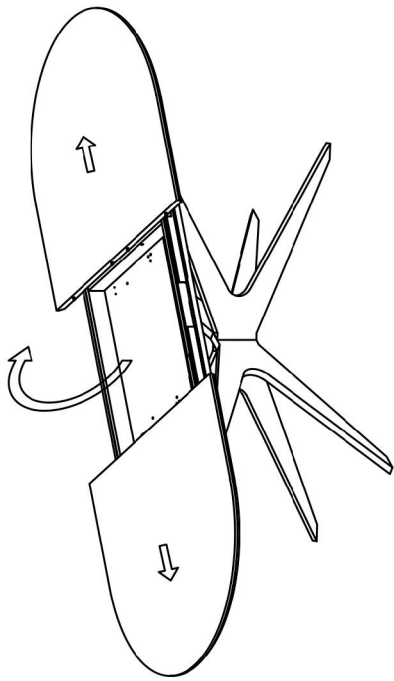

5

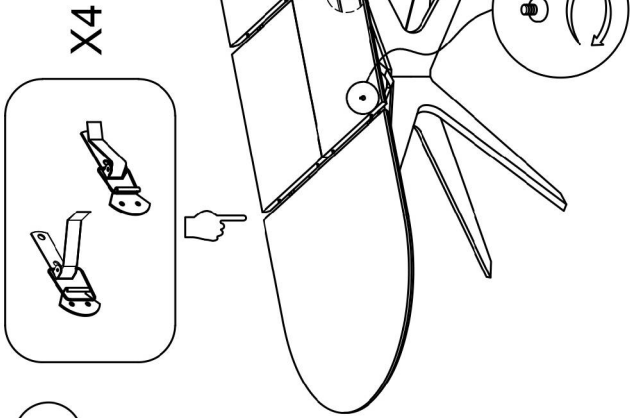

4

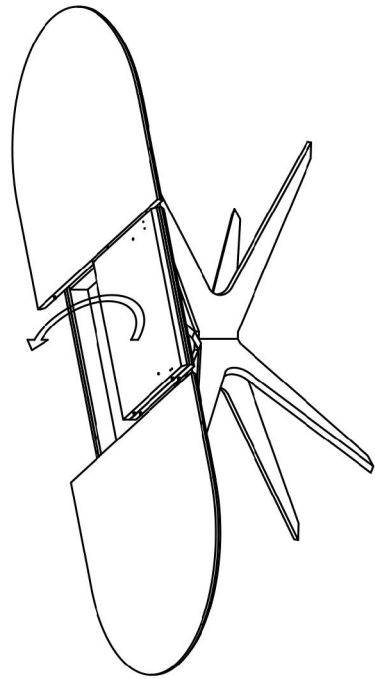

6

