

1.

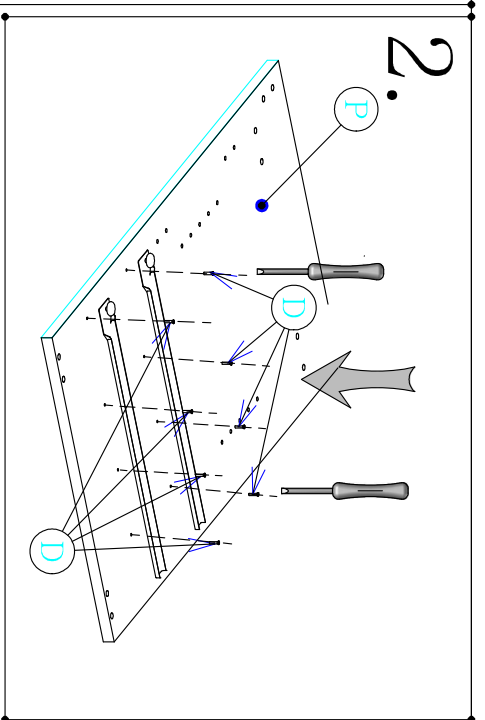

2.

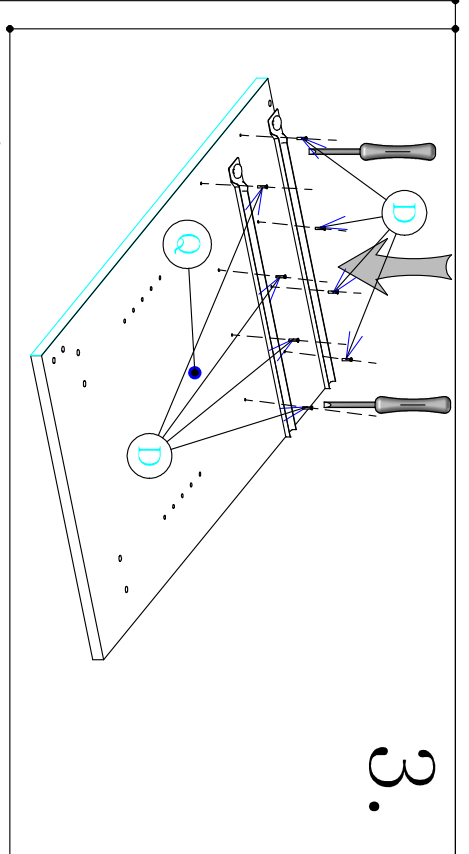

3.

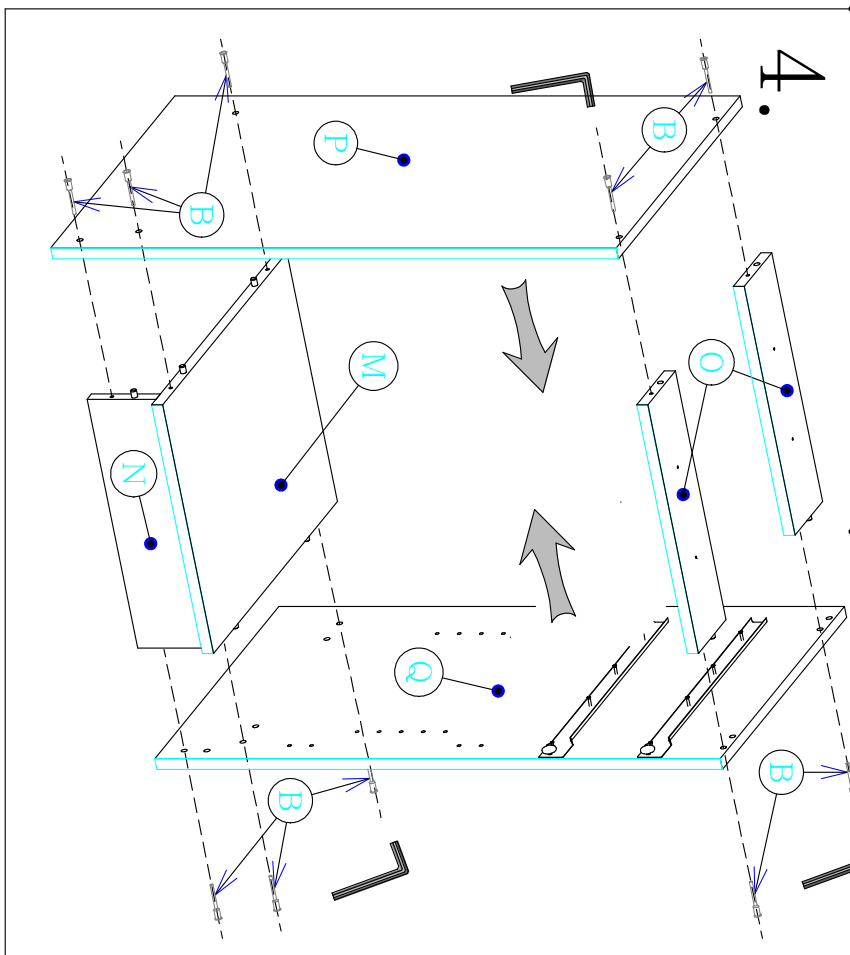

4.

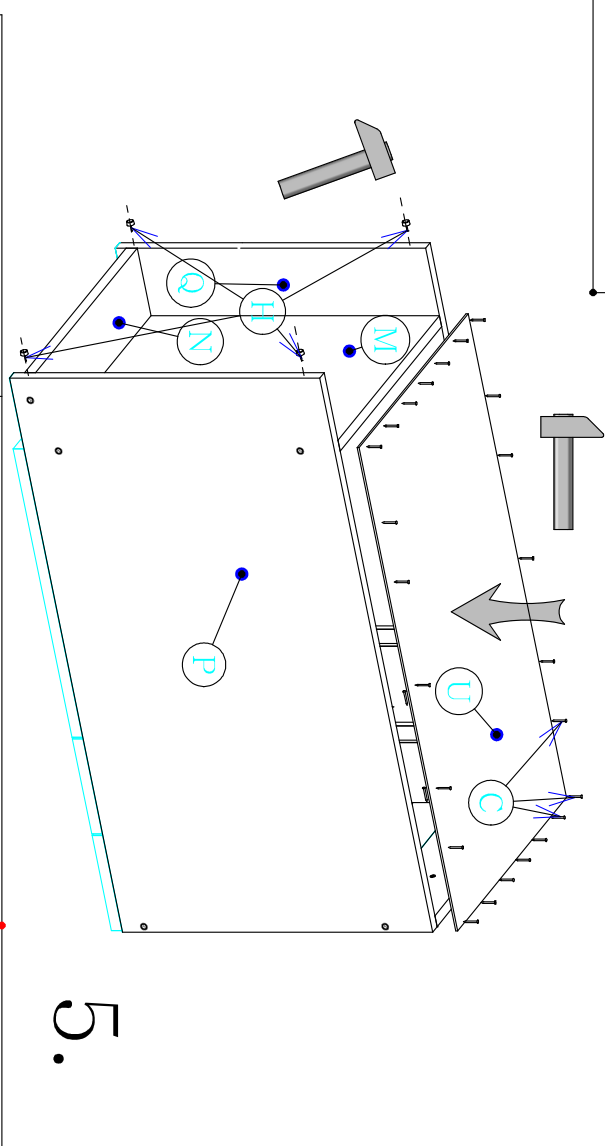

5.

Assembly Instructions			1/2
D40-SZ	External tools needed for assembly: hammer, screwdriver		
Perta	Optional tools : Power drill with screwdriver bit		
260cm	Please follow steps		

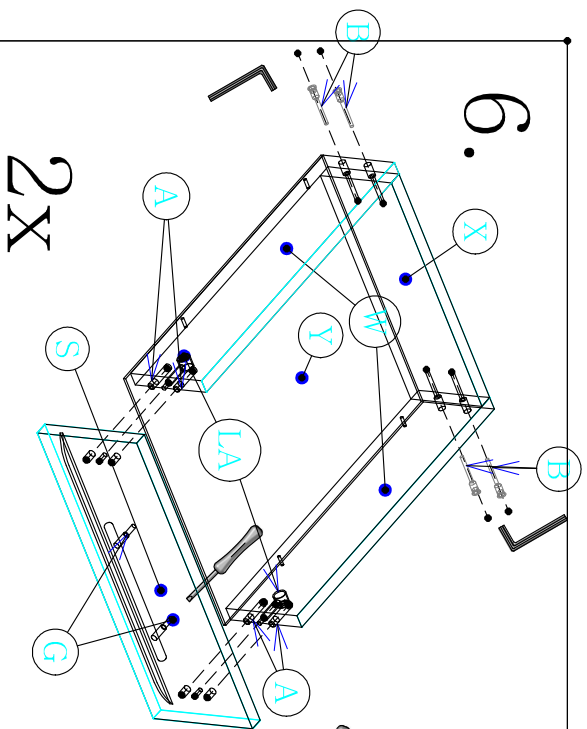

9.

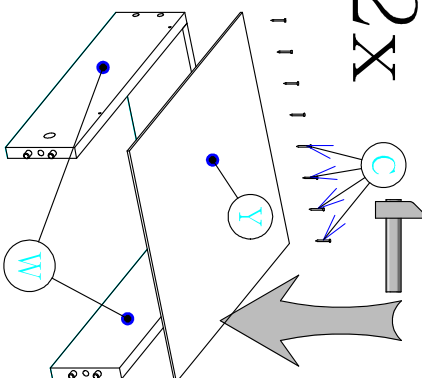
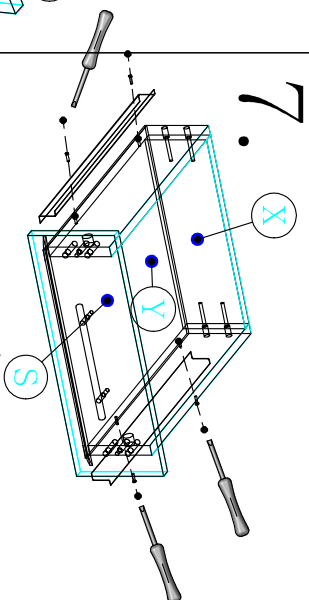
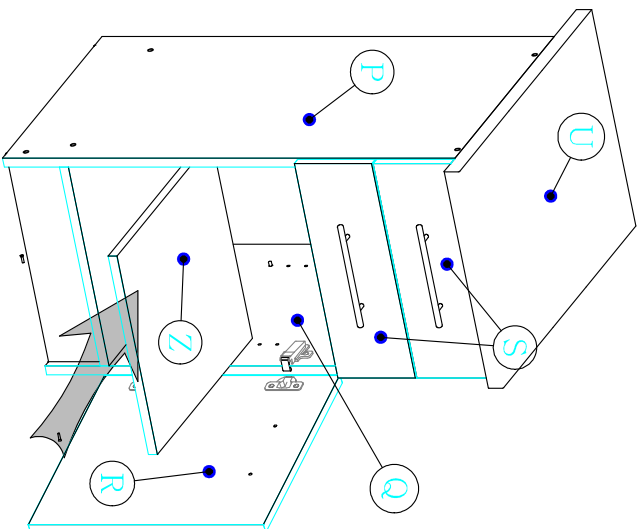

8.

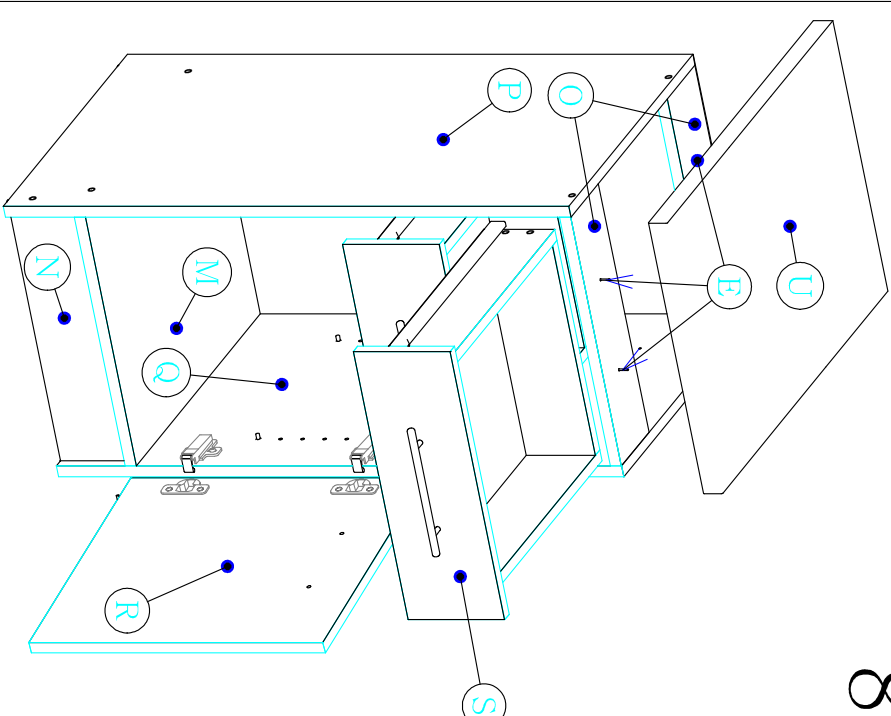

Assembly Instructions

HALMAR

2/2

D40-SZ

External tools needed for assembly: hammer, screwdriver

Perta

Optional tools :Power drill with screwdriver bit

260cm

Please follow steps

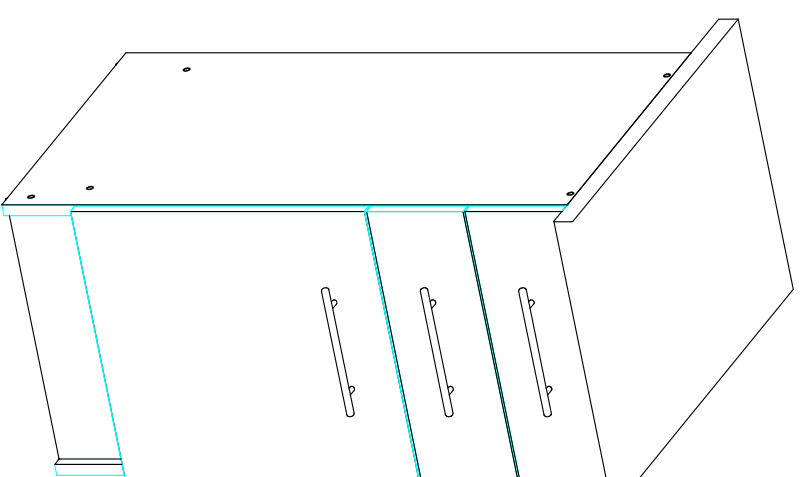
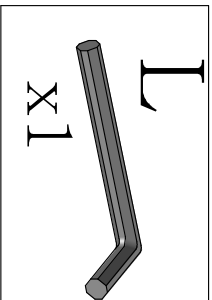
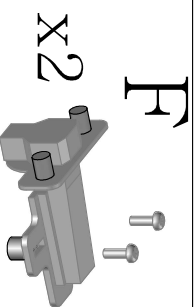
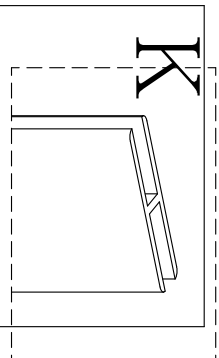
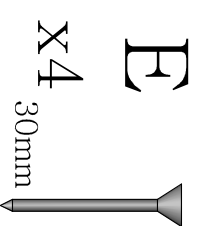
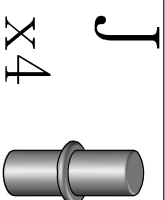
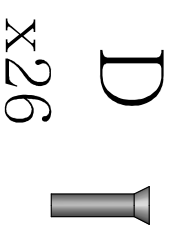
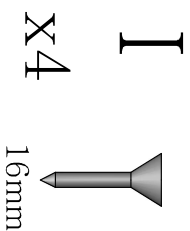
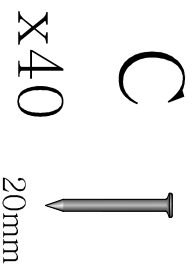
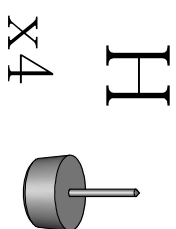
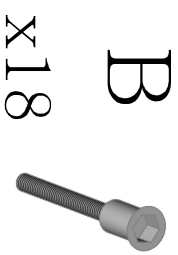
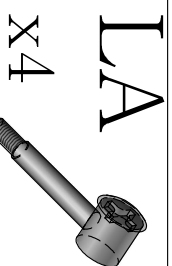
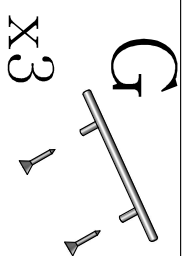
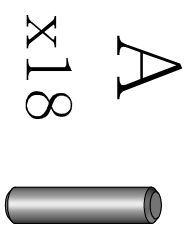

Assembly Instructions



3

D40-SZ-

External tools needed for assembly: hammer, screwdriver

Perła

Optional tools :Power drill with screwdriver bit

260cm

Please follow steps