

1.

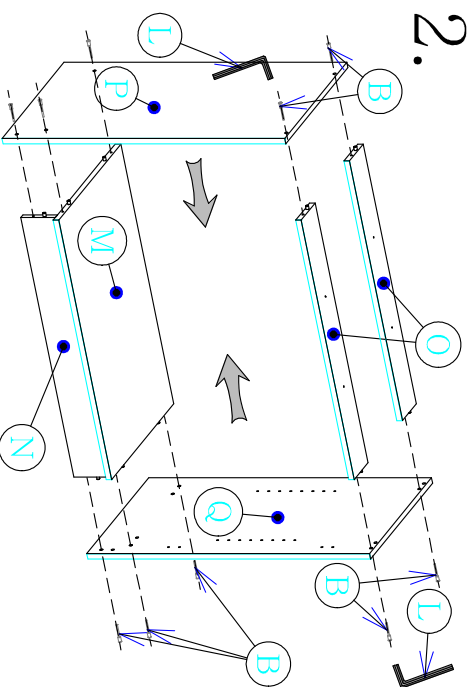

2.

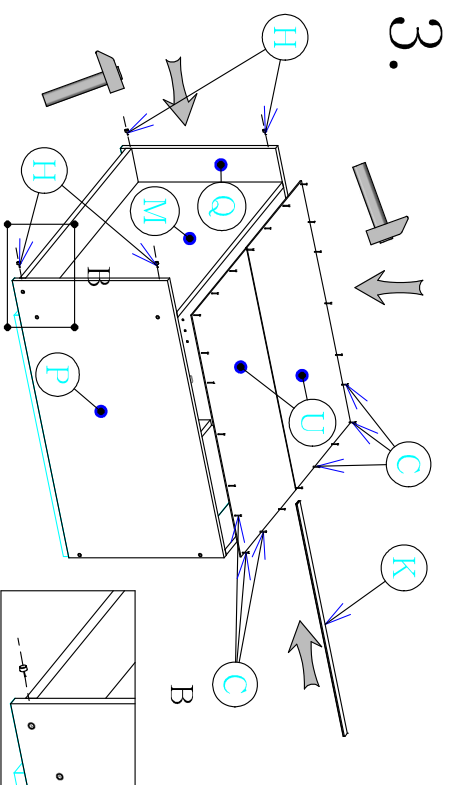

3.

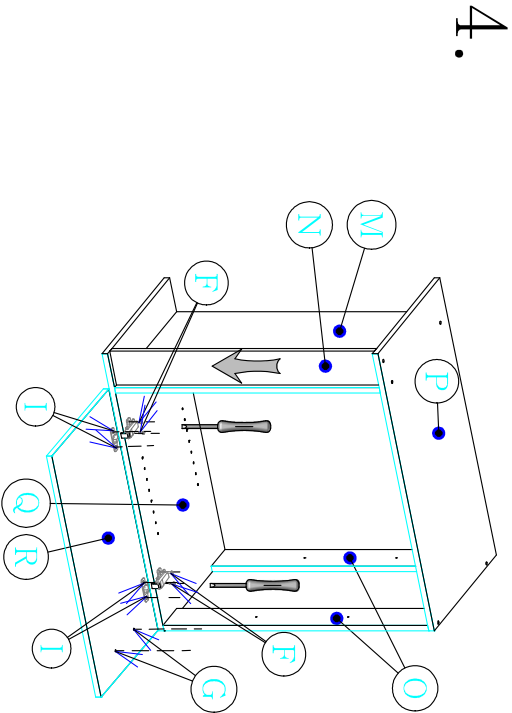

4.

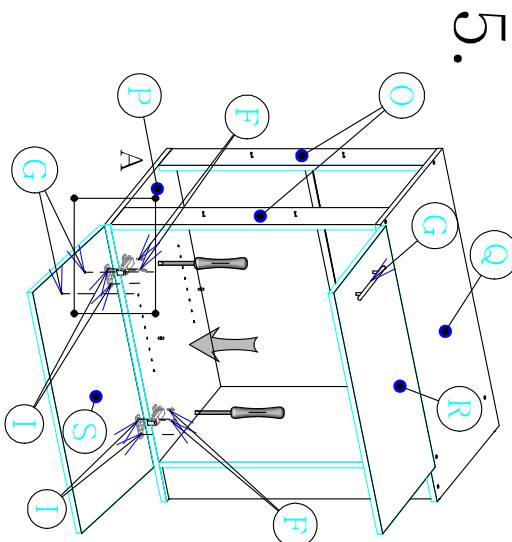

5.

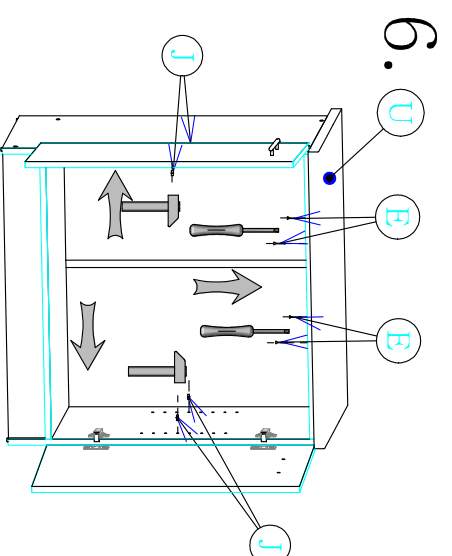

6.

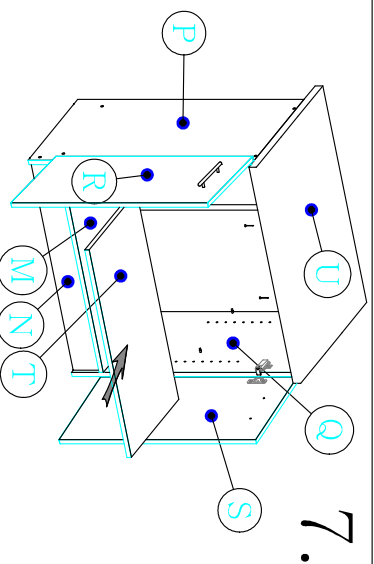

7.

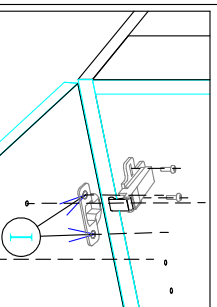

A

Assembly Instructions

HALMAR

1/1

D80

Perta

260cm

External tools needed for assembly: hammer, screwdriver

Optional tools : Power drill with screwdriver bit

Please follow steps

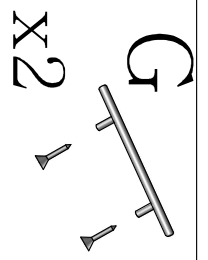
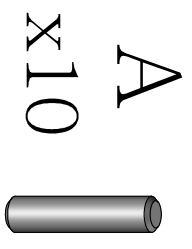

LA

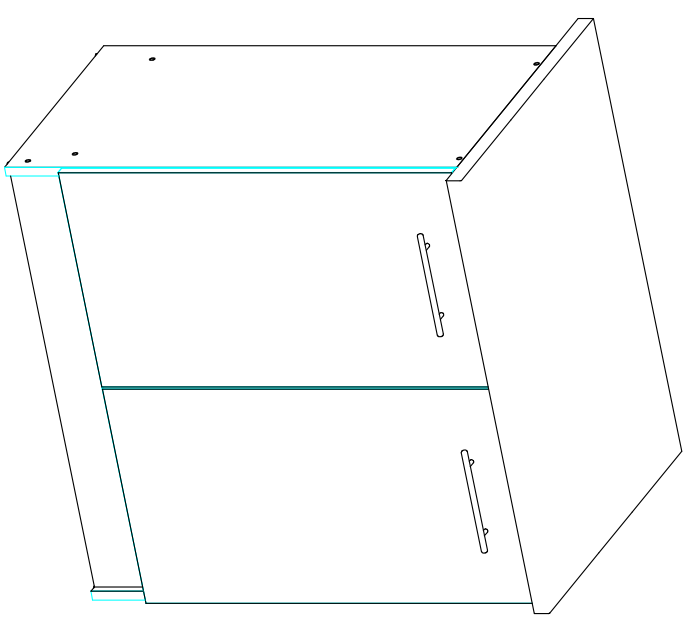
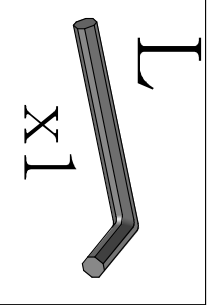
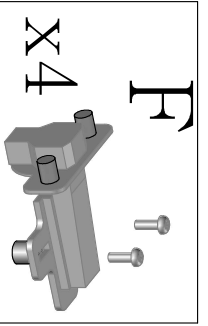
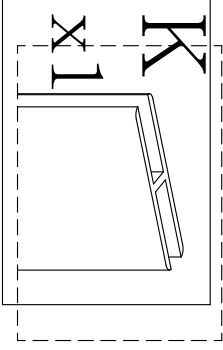
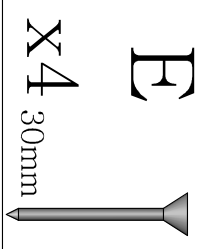
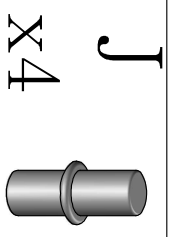
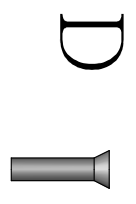
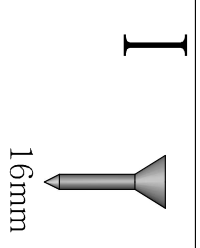
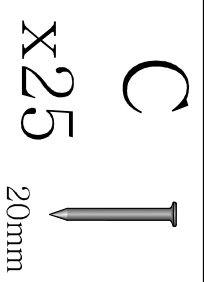
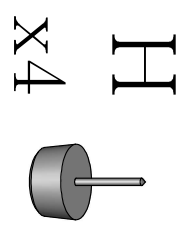
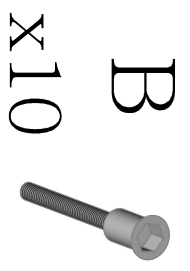
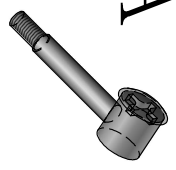

Assembly Instructions



2

D80_

External tools needed for assembly: hammer, screwdriver

Perla

Optional tools :Power drill with screwdriver bit

260cm

Please follow steps