

Assembly Instructions			1/1
D80-ZL	External tools needed for assembly: hammer, screwdriver		
Perla	Optional tools : Power drill with screwdriver bit	Please follow steps	
260cm			

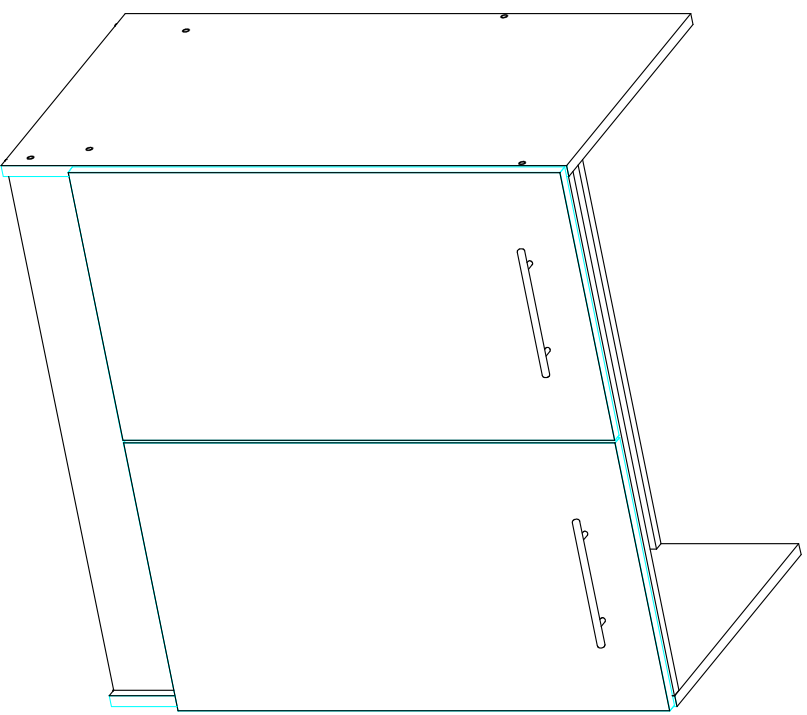

Assembly Instructions

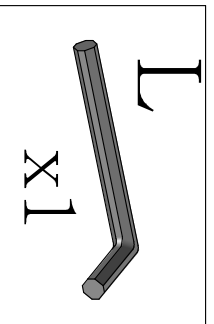
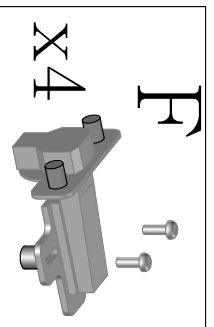
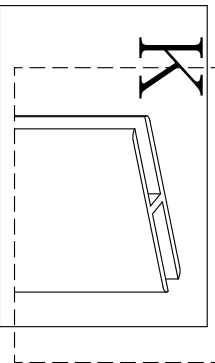
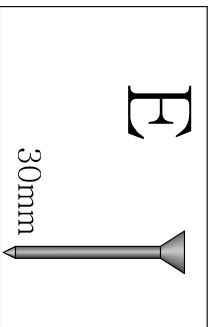
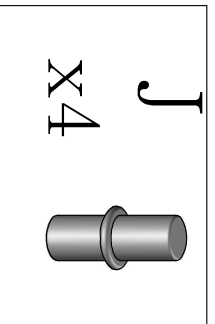
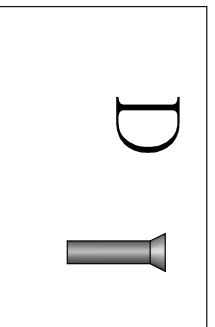
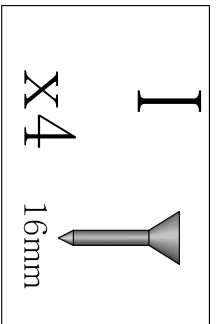
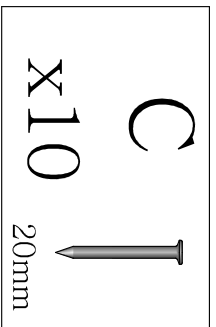
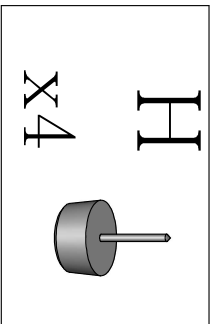
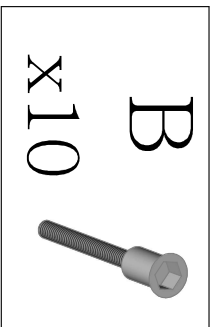
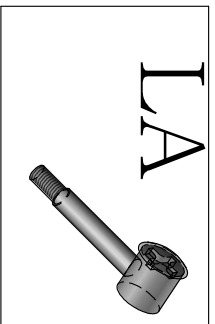
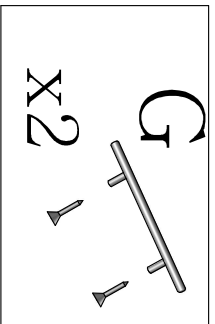
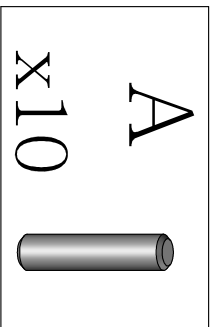

2

D80-ZL_

External tools needed for assembly: hammer, screwdriver

Perła

Optional tools :Power drill with screwdriver bit

260cm

Please follow steps