

1.

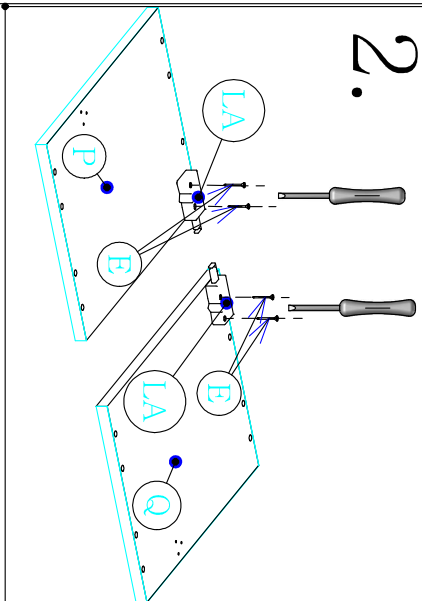

2.

5.

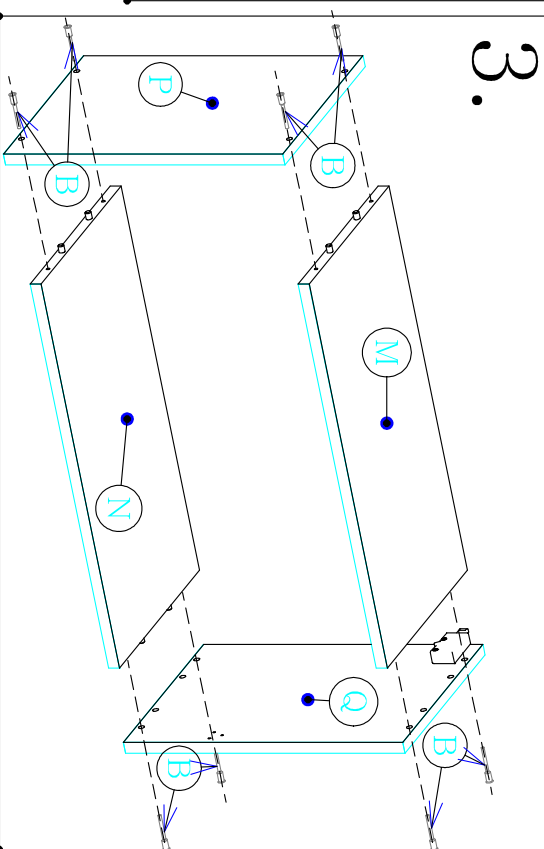

3.

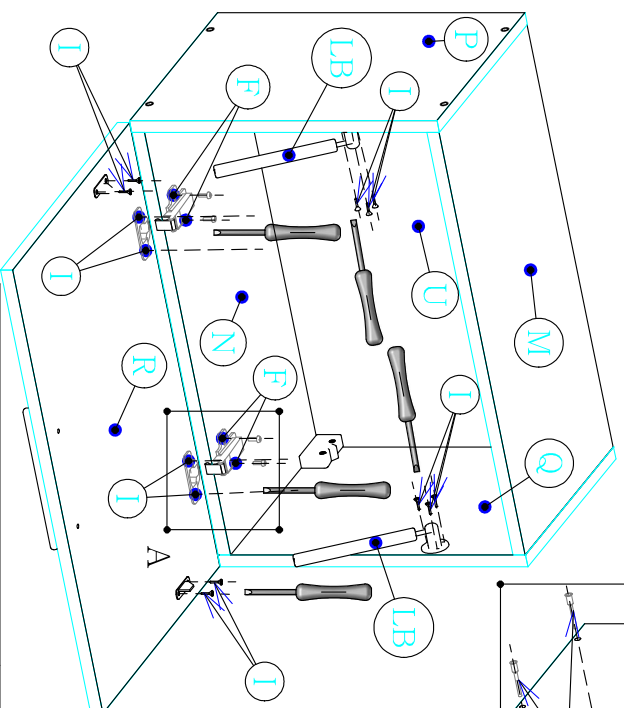

4.

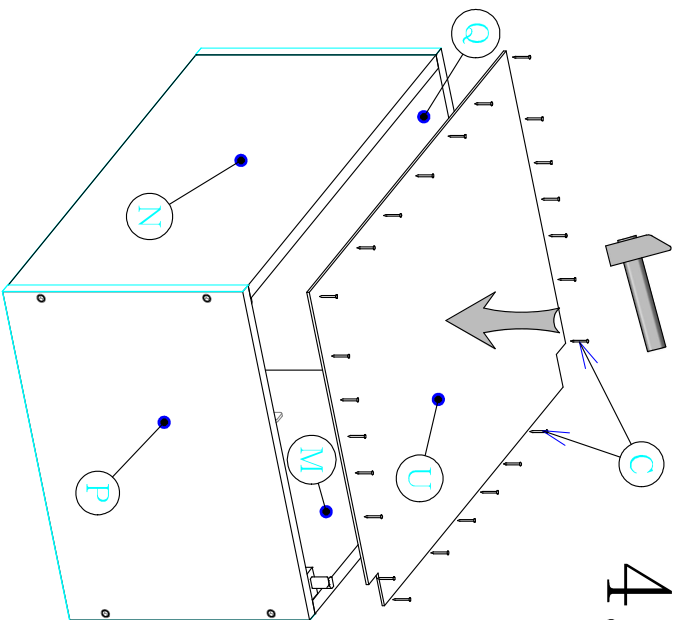

Assembly Instructions

G60-OK

Perta

260cm

HALMAR

1/2

External tools needed for assembly: hammer, screwdriver

Optional tools :Power drill with screwdriver bit

Please follow steps

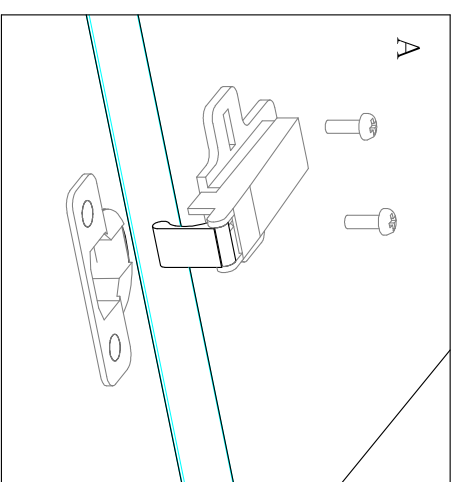

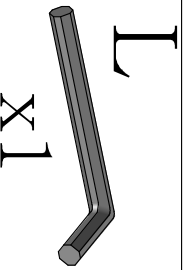
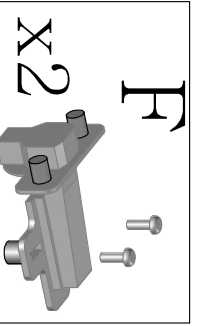
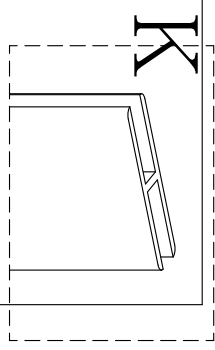
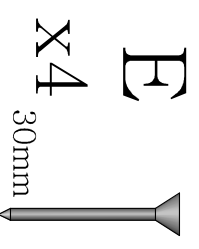
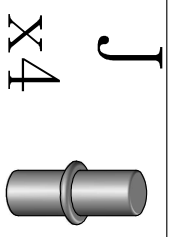
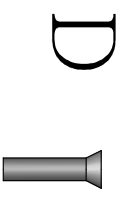
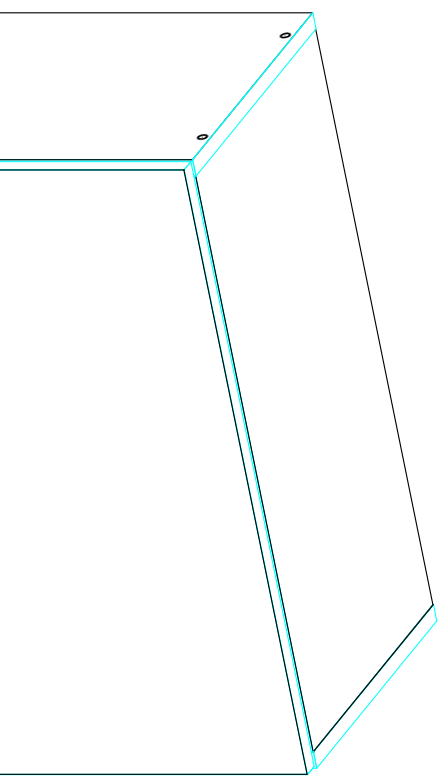
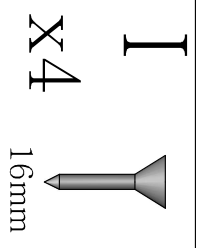
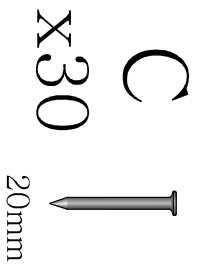
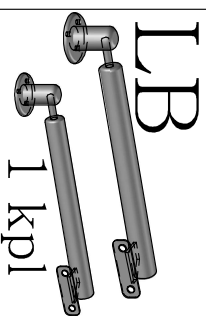
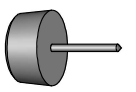
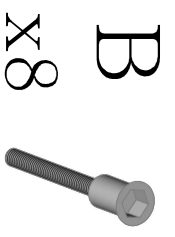
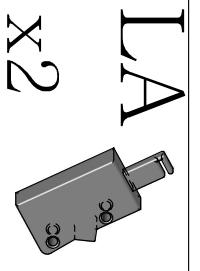
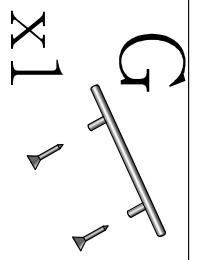
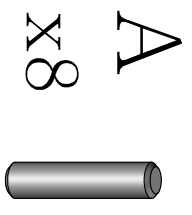

Assembly Instructions



2

G60-OK_

External tools needed for assembly: hammer, screwdriver

Perla

Optional tools :Power drill with screwdriver bit

260cm

Please follow steps